



INSTYTUT TECHNIKI BUDOWLANEJ
PL 00-611 WARSZAWA
ul. Filtrowa 1
tel.: (+48 22) 825-04-71
(+48 22) 825-76-55
fax: (+48 22) 825-52-86
www.itb.pl



Member of



www.eota.eu

European Technical Assessment

**ETA-16/0796
of 24/10/2016**

General Part

Technical Assessment Body issuing the European Technical Assessment

Instytut Techniki Budowlanej

Trade name of the construction product

KOELNER VSFree, KOELNER VSFree-W

Product family to which the construction product belongs

Bonded anchor with anchor rod made of galvanized steel for use in non-cracked concrete

Manufacturer

RAWLPLUG S.A.
ul. Kwidzyńska 6
51-416 Wrocław
Poland

Manufacturing plant)

Manufacturing Plant no. 3

This European Technical Assessment contains

15 pages including 3 Annexes which form an integral part of this Assessment

This European Technical Assessment is issued in accordance with Regulation (EU) No 305/2011, on the basis of

Guideline for European Technical Approval ETAG 001, Edition April 2013 "Metal anchors for use in concrete – Part 1: Anchors in general and Part 5: Bonded anchors", used as European Assessment Document (EAD)

This European Technical Assessment is issued by the Technical Assessment Body in its official language. Translations of this European Technical Assessment in other languages shall fully correspond to the original issued document and should be identified as such.

Communication of this European Technical Assessment, including transmission by electronic means, shall be in full. However, partial reproduction may be made, with the written consent of the issuing Technical Assessment Body. Any partial reproduction has to be identified as such.

Specific Part

1 Technical description of the product

The KOELNER VSFree, KOELNER VSFree-W are a bonded anchors (injection type) consisting of a injection mortar cartridge using an applicator gun equipped with a special mixing nozzle and threaded anchor rod of the sizes M8 to M30 made of galvanized carbon steel, with hexagon nut and washer.

The threaded rod is placed into a drilled hole previously injected (using an applicator gun) with a mortar with a slow and slight twisting motion. The threaded rod is anchored by the bond between rod, mortar and concrete.

The threaded rods are available for all diameters with three type of tip end: a one side 45° chamfer, a two sides 45° chamfer or a flat. The threaded rods are either delivered with the mortar cartridges or commercial standard threaded rods purchased separately. The mortar cartridges are available in different sizes and types.

An illustration and the description of the products are given in Annex A1 to A3.

2 Specification of the intended use in accordance with the applicable European Assessment Document (EAD)

The performances given in Section 3 are only valid if the anchors are used in compliance with the specifications and conditions given in Annex B1 to B5.

The performances given in this European Technical Assessment are based on an assumed working life of the anchor of 50 years. The indications given on the working life cannot be interpreted as a guarantee given by the producer or the Technical Assessment Body, but are to be regarded only as a means for choosing the right products in relation to the expected economically reasonable working life of the works.

3 Performance of the product and references to the methods used for its assessment

3.1 Performance of the product

3.1.1 Mechanical resistance and stability (BWR 1)

The essential characteristic is detailed in the Annex C1 to C3.

3.1.2 Safety in case of fire (BWR 2)

No performance assessed.

3.1.3 Hygiene, health and the environment (BWR 3)

Regarding dangerous substances there may be requirements applicable to the products falling within its scope (e.g. transposed European legislation and national laws, regulations and administrative provisions). In order to meet the provisions of the Construction Products Regulation, these requirements need also to be complied with, when and where they apply..

3.1.4 Safety and accessibility in use BWR 4)

For Basic Requirement Safety in use the same criteria are valid as for Basic Requirement Mechanical resistance and stability (BWR 1).

3.1.5 Sustainable use of natural resources (BWR 7)

No performance assessed.

3.2 Methods used for the assessment

The assessment of fitness of the anchors for decelerated intended use in relation to the requirements for mechanical resistance and stability and safety in use in the sense of the Basic Requirements 1 and 4 has been made in accordance with the ETAG 001 "Metal anchors for use in concrete", Part 1: "Anchors in general" and Part 5: "Bonded anchors", on the basis of Option 1 and 7.

4 Assessment and verification of constancy of performance (hereinafter AVCP) system applied, with reference to its legal base

According to Decision 96/582/EC of the European Commission the system of assessment and verification of constancy of performance (see Annex V to Regulation (EU) No 305/2011) given in the following table applies.

Product	Intended use	Level or class	System
Metal anchors for use in concrete	For fixing and/or supporting to concrete structural elements (which contributes to the stability of the works) or heavy units	–	1

5 Technical details necessary for the implementation of the AVCP system, as provided for in the applicable European Assessment Document (EAD)

Technical details necessary for the implementation of the AVCP system are laid down in the control plan which is deposited at Instytut Techniki Budowlanej.

For type testing the results of the tests performed as part of the assessment for the European Technical Assessment shall be used unless there are changes in the production line or plant. In such cases the necessary type testing has to be agreed between Instytut Techniki Budowlanej and the Notified Body.

Issued in Warsaw on 24/10/2016 by Instytut Techniki Budowlanej

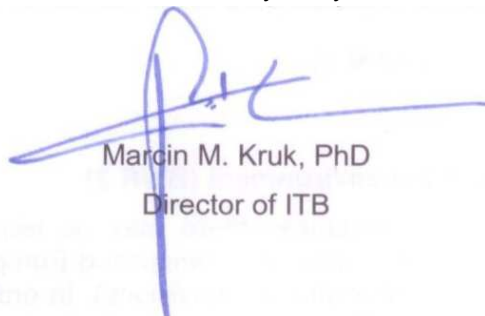

Marcin M. Kruk, PhD
Director of ITB

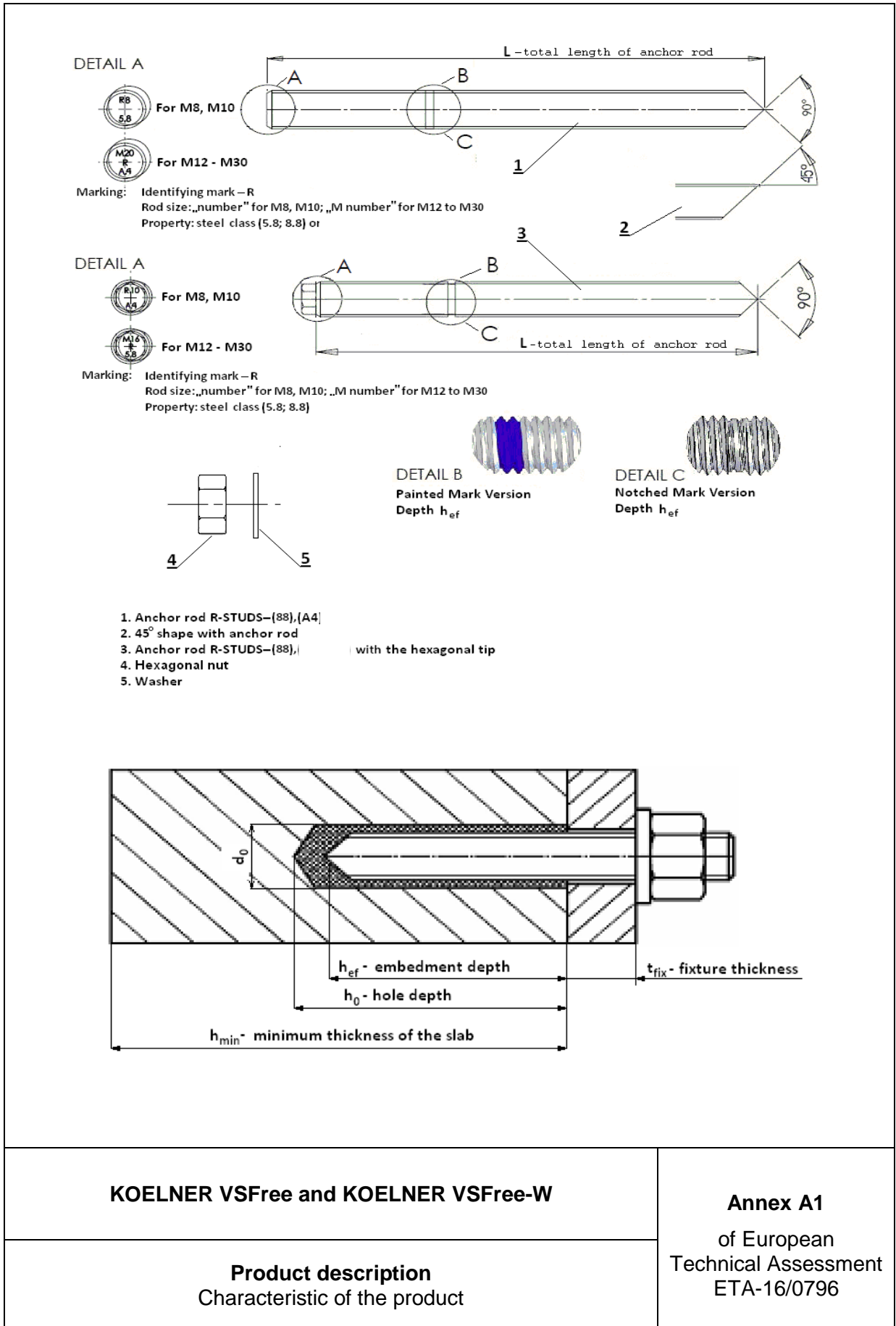

Table A1: Threaded rods

Part	Designation
	Steel, zinc plated
Threaded rod	Steel, property class 5.8 to 8.8, acc. to EN ISO 898-1 electroplated $\geq 5 \mu\text{m}$ acc. to EN ISO 4042 or hot-dip galvanized $\geq 45 \mu\text{m}$ acc. to EN ISO 10684
Hexagon nut	Steel, property class 5 to 12, acc. to EN 20898-2; electroplated $\geq 5 \mu\text{m}$ acc. to EN ISO 4042 or hot-dip galvanized $\geq 45 \mu\text{m}$ acc. to EN ISO 10684
Washer	Steel, acc. to EN ISO 7089; electroplated $\geq 5 \mu\text{m}$ acc. to EN ISO 4042 or hot-dip galvanized $\geq 45 \mu\text{m}$ acc. to EN ISO 10684

Commercial standard threaded rods can be used

Table A2: Injection mortars

Product	Composition
KOELNER VSFree KOELNER VSFree-W	Bonding agent: vinylester styrene free resin Hardener: dibenzoyl peroxide Additive: quartz sand (filler)

KOELNER VSFree and KOELNER VSFree-W

Product description
Materials

Annex A2
of European
Technical Assessment
ETA-16/0796

Coaxial cartridge -

150 ml, 280 ml, 300 ml, 310 ml, 330 ml, 380 ml, 400 ml, 410 ml, 420 ml.

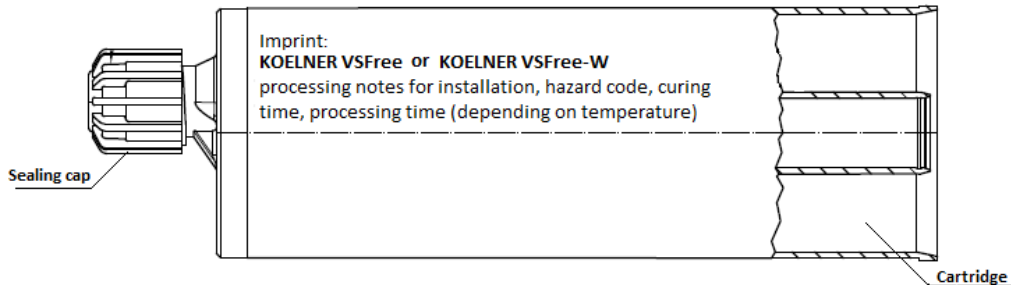

Side by side cartridge -

345 ml, 425 ml, 825 ml.

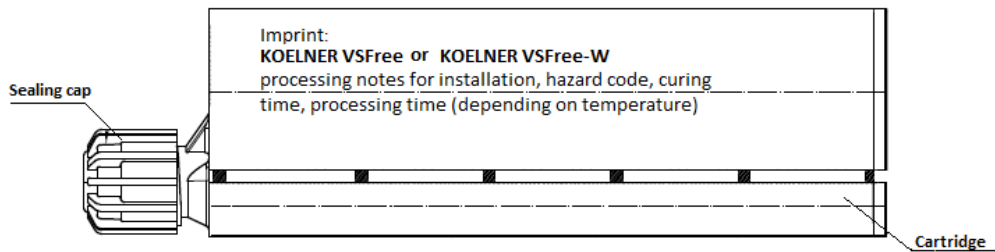

Cartridge a single component for two part foil calcsules -

150 ml, 175 ml, 280ml, 300 ml, 310 ml, 380 ml, 400 ml, 550 ml, 600 ml.

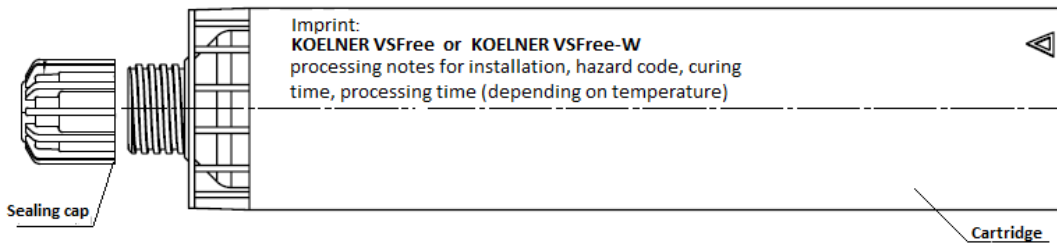

Mixer for cartridge

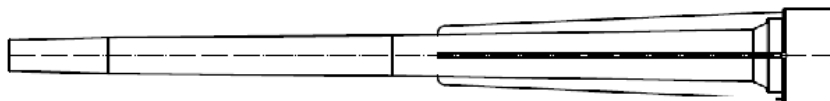

<p>KOELNER VSFree and KOELNER VSFree-W</p>	<p>Annex A3</p>
<p>Product description Cartridge types and sizes</p>	<p>of European Technical Assessment ETA-16/0796</p>

SPECIFICATION OF INTENDED USE

Use:

The anchors are intended to be used for anchorages for which requirements for mechanical resistance and stability and safety in use in the sense of the Basic Requirements 1 and 4 of Regulation (EU) 305/2011 shall be fulfilled and failure of anchorages made with these products would compromise the stability of the works, cause risk to human life and/or lead to considerable economic consequences.

Anchors subject to:

Static and quasi-static loads: sizes from M8 to M30.

Base material:

- Reinforced or unreinforced normal weight concrete of strength class C20/25 at minimum to C50/60 at maximum according to EN 206.
- Non cracked concrete: sizes from M8 to M30.

Temperature range:

The anchors may be used in the following temperature range:

- -40°C to +40°C (max. short term temperature +40°C and max. long term temperature +24°C).
- -40°C to +80°C (max. short term temperature +80°C and max. long term temperature +50°C).

Use conditions (environmental conditions):

- Structures subject to dry internal conditions (galvanized steel).

Installation:

- Dry or wet concrete (use category 1): sizes from M8 to M30.
- The anchors are suitable for rotary hammer drilled holes: sizes from M8 to M30.

Design methods:

EOTA Technical Report TR029 (September 2010) or CEN/TS 1992-4.

<p>KOELNER VSFree and KOELNER VSFree-W</p>	<p>Annex B1 of European Technical Assessment ETA-16/0796</p>
<p>Intended use Intended use</p>	

Table B1: Installation data

Size		M8	M10	M12	M16	M20	M24	M30	
Diameter of anchor rod	d [mm]	8	10	12	16	20	24	30	
Nominal drilling diameter	d ₀ [mm]	10	12	14	18	24	28	35	
Maximum diameter hole in the fixture	d _{fix} [mm]	9	12	14	18	22	26	32	
Effective embedment depth	h _{ef,min} [mm]	60	70	80	100	120	140	165	
	h _{ef,max} [mm]	100	120	145	190	240	290	360	
Depth of the drilling hole	h ₀ [mm]	h _{ef} + 5 mm							
Minimum thickness of the concrete member	h _{min} [mm]	h _{ef} + 30 mm; ≥ 100 mm				h _{ef} + 2 · d ₀			
Torque moment	T _{inst} [N·m]	10	20	40	80	120	180	300	
Minimum spacing	s _{min} [mm]	0,5 · h _{ef} ≥ 40 mm							
Minimum edge distance	c _{min} [mm]	0,5 · h _{ef} ≥ 40 mm							

KOELNER VSFree and KOELNER VSFree-W

Intended use
Installation data

Annex B2
of European
Technical Assessment
ETA-16/0796

Table B2: Processing time and minimum curing time

Mortar temperature	Concrete temperature	Processing (open) time		Minimum curing time ¹⁾	
		KOELNER VSFree	KOELNER VSFree-W	KOELNER VSFree	KOELNER VSFree-W
5°C	-20°C	-	100 min.	-	24 h
5°C	-15°C	-	60 min.	-	16 h
5°C	-10°C	-	30 min.	-	8 h
5°C	-5°C	60 min.	16 min.	6 h	4 h
5°C	0°C	40 min.	12 min.	3 h	2 h
5°C	5°C	20 min.	8 min.	2 h	1 h
10°C	10°C	12 min.	5 min.	80 min.	45 min.
15°C	15°C	8 min.	3 min.	60 min.	30 min.
20°C	20°C	5 min.	2 min.	45 min.	10 min.
25°C	25°C	-	-	-	-
25°C	30°C	2 min.	-	20 min.	-
25°C	40°C	0,5 min.	-	10 min.	-

1) Curing time shall be doubled for the wet concrete. Minimum mortar temperature for installation +5°C; maximum mortar temperature for installation +25°C.

KOELNER VSFree and KOELNER VSFree-W

Intended use
Processing time and curing time

Annex B3
of European
Technical Assessment
ETA-16/0796

Additional mixer extension

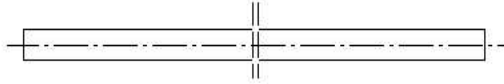

*Variable length from 300mm up to 1000mm.

Manual blower pump

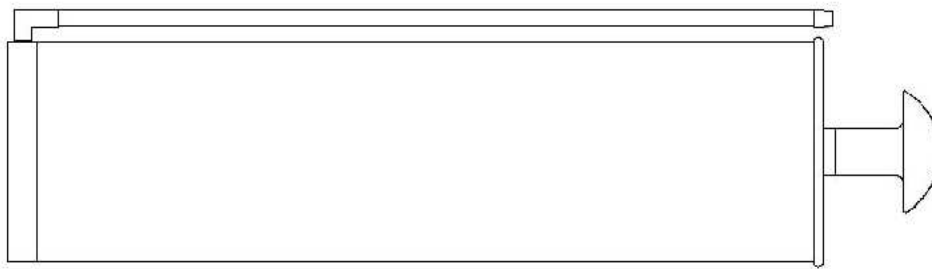

Steel brush

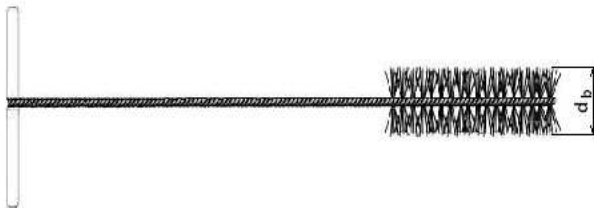

Brush diameter

Size rod	M8	M10	M12	M16	M20	M24	M30
Brushes diameter d_b (mm)	12	14	16	20	26	30	37

KOELNER VSFree and KOELNER VSFree-W

Intended use
Cleaning tools

Annex B4
of European
Technical Assessment
ETA-16/0796





	<p>Drill a hole to the required diameter and depth using a rotary hammer drilling machine.</p>
	<p>Starting from the drill hole bottom blow the hole at least 4 times using the hand pump.</p>
	<p>Using the specified brush, mechanically brush out the hole at least 4 times.</p>
	<p>Starting from the drill hole bottom, blow at least 4 times with the hand pump.</p>
	<p>Insert the mixing nozzle to the far end of the hole and inject the mortar, slowly withdrawing the nozzle as the hole is filled to 2/3 of its' depth.</p>
	<p>Immediately insert the rod, slowly and with a slight twisting motion. Remove excess of mortar around the hole before it sets.</p>
	<p>Leave the fixing undisturbed until the cure time elapses.</p>
	<p>Attach the fixture and tighten the nut to the required torque.</p>
<p>KOELNER VSFree and KOELNER VSFree-W</p>	
<p>Intended use Installation instruction</p>	<p>Annex B5 of European Technical Assessment ETA-16/0796</p>

Table C1: Characteristic values for tension loads

Size			M8	M10	M12	M16	M20	M24	M30	
Steel failure										
Steel failure with threaded rod grade 5.8										
Characteristic resistance	$N_{Rk,s}$	[kN]	18	29	42	78	122	176	280	
Partial safety factor	$\gamma_{Ms}^{1)}$	[-]	1,50							
Steel failure with threaded rod grade 8.8										
Characteristic resistance	$N_{Rk,s}$	[kN]	29	46	67	126	196	282	449	
Partial safety factor	$\gamma_{Ms}^{1)}$	[-]	1,50							
Combined pull-out and concrete cone failure										
Characteristic bond resistance in non-cracked concrete C20/25										
Temperature range I: 40°C/24°C	$\tau_{Rk,ucr}$	[N/mm ²]	13	13	13	11	9,5	9	7	
Temperature range II: 80°C/50°C	$\tau_{Rk,ucr}$	[N/mm ²]	10	11	10	9	7,5	7	5,5	
Increasing factor for $\tau_{Rk,ucr}$ in non-cracked concrete	ψ_c	C30/37	1,04				1,0			
		C40/50	1,07				1,0			
		C50/60	1,09				1,0			
Partial safety factors for use category 1	$\gamma_{Mc}=\gamma_{Mp}=\gamma_{Msp}^{1)}$	[-]	1,8	1,8	1,8	1,8	1,8	2,1	2,1	
Splitting failure										
Effective anchorage depth h_{ef}	min	[mm]	60	70	80	100	120	140	165	
	max	[mm]	100	120	145	190	240	290	360	
Edge distance	$c_{cr,sp}$ for h_{min}	[mm]	$2,5 \cdot h_{ef}$		$2,0 \cdot h_{ef}$		$1,5 \cdot h_{ef}$			
	$c_{cr,sp}$ for $h_{min} < h^2 < 2 h_{ef}$ ($c_{cr,sp}$ from linear interpolation)	[mm]								
	$c_{cr,sp}$ for $h \geq 2 h_{ef}$	[mm]	$c_{cr,Np}$							
Spacing	$s_{cr,sp}$	[mm]	$2,0 \cdot c_{cr,sp}$							

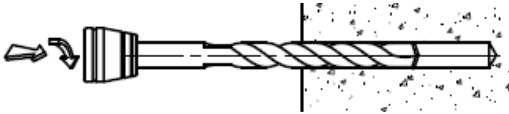
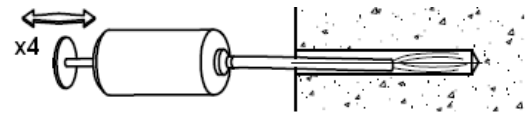
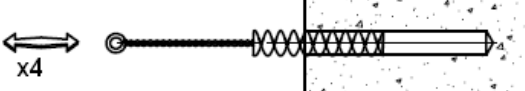
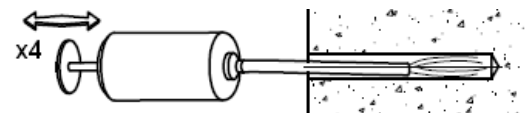
¹⁾ in the absence of national regulations

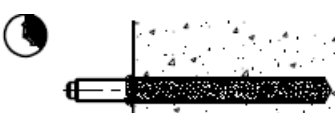
²⁾ h – concrete member thickness

Note: Design method according to TR 029

KOELNER VFree and KOELNER VFree-W

Performances
Characteristic resistance under tension loads
in non-cracked concrete

Annex C1
of European
Technical Assessment
ETA-16/0796

Table C2: Shear loads for steel failure without lever arm

Size			M8	M10	M12	M16	M20	M24	M30
Steel failure with threaded rod grade 5.8									
Characteristic resistance	$V_{Rk,s}$	[kN]	9	14	21	39	61	88	140
Partial safety factor	γ_{Ms}	[-]	1,25						
Steel failure with threaded rod grade 8.8									
Characteristic resistance	$V_{Rk,s}$	[kN]	15	23	34	63	98	141	224
Partial safety factor	γ_{Ms}	[-]	1,25						

Table C4: Shear loads for steel failure with lever arm

Size			M8	M10	M12	M16	M20	M24	M30
Steel failure with threaded rod grade 5.8									
Characteristic resistance	$M^0_{Rk,s}$	[Nm]	19	37	65	166	324	561	1124
Partial safety factor	γ_{Ms}	[-]	1,25						
Steel failure with threaded rod grade 8.8									
Characteristic resistance	$M^0_{Rk,s}$	[Nm]	30	60	105	266	519	898	1799
Partial safety factor	γ_{Ms}	[-]	1,25						

Table C5: Characteristic values for shear loads – pry out and concrete edge failure

Size			M8	M10	M12	M16	M20	M24	M30
Effective anchorage depth h_{ef}	min	[mm]	60	70	80	100	120	140	165
	max	[mm]	100	120	145	190	240	290	360
Pry out failure									
Factor	k	[-]	2	2	2	2	2	2	2
Partial safety factor ¹⁾	γ_{Mp}	[-]	1,5						
Concrete edge failure: see clause 5.2.3.4 of Technical Report TR 029									
Partial safety factor ¹⁾	γ_{Mc}	[-]	1,5						

¹⁾ in the absence of national regulation

KOELNER VSFree and KOELNER VSFree-W

Performances
Characteristic resistance under shear loads

Annex C2
of European
Technical Assessment
ETA-16/0796

Table C6: Displacement under tension loads – non-cracked concrete

Size			M8	M10	M12	M16	M20	M24	M30
Characteristic displacement in non-cracked concrete C20/25 to C50/60 under tension loads									
Admissible service load ¹⁾	F	[kN]	8,5	12,8	16,6	23,9	30,5	35,4	40,0
Displacement	δ_{N0}	[mm]	0,25	0,35	0,40	0,40	0,45	0,50	0,50
	$\delta_{N\infty}$	[mm]	0,60	0,60	0,60	0,60	0,60	0,60	0,60

$$F = F_{Rk} / \gamma_F \cdot \gamma_{Mc}, \text{ with } \gamma_F = 1,4$$

These values are suitable for each temperature range and categories specified in Annex B1

Table C7: Displacement under tension loads – cracked concrete

Size			M12	M16	M20	M24
Characteristic displacement in cracked concrete C20/25 to C50/60 under tension loads						
Admissible service load ¹⁾	F	[kN]	7,9	9,9	11,9	15,9
Displacement	δ_{N0}	[mm]	0,10	0,30	0,30	0,32
	$\delta_{N\infty}$	[mm]	2,6	2,9	3,0	3,1

$$^1) F = F_{Rk} / \gamma_F \cdot \gamma_{Mc}, \text{ with } \gamma_F = 1,4$$

These values are suitable for each temperature range and categories specified in Annex B1

Table C8: Displacement under shear loads

Size			M8	M10	M12	M16	M20	M24	M30
Characteristic displacement under shear loads									
Admissible service load ¹⁾	F	[kN]	3,7	5,8	8,4	15,7	24,5	35,3	55,6
Displacement	δ_{V0}	[mm]	2,5	2,5	2,5	2,5	2,5	2,5	2,5
	$\delta_{V\infty}$	[mm]	3,7	3,7	3,7	3,7	3,7	3,7	3,7

$$^1) F = F_{Rk} / \gamma_F \cdot \gamma_{Mc}, \text{ with } \gamma_F = 1,4$$

These values are suitable for each temperature range and categories specified in Annex B1

KOELNER VSFree and KOELNER VSFree-W

Performances
Displacement under service loads: tension and shear loads

Annex C3
of European
Technical Assessment
ETA-16/0796